

Major Ratings and Characteristics

Characteristics	75HQ...	Units
$I_{F(AV)}$ Rectangular waveform	75	A
V_{RRM} range	30 to 45	V
I_{FSM} @ $t_p=5\mu s$ sine	9000	A
V_F @ 75 Apk, $T_J=125^\circ C$	0.63	V
T_J range	-65 to 175	$^\circ C$

Description/ Features

The 75HQ Schottky rectifier series has been optimized for low reverse leakage at high temperature. The proprietary barrier technology allows for reliable operation up to 175 °C junction temperature. Typical applications are in switching power supplies, converters, free-wheeling diodes, and reverse battery protection.

- 175 °C T_J operation
- Low forward voltage drop
- High frequency operation
- Guard ring for enhanced ruggedness and long term reliability
- Hermetic packaging

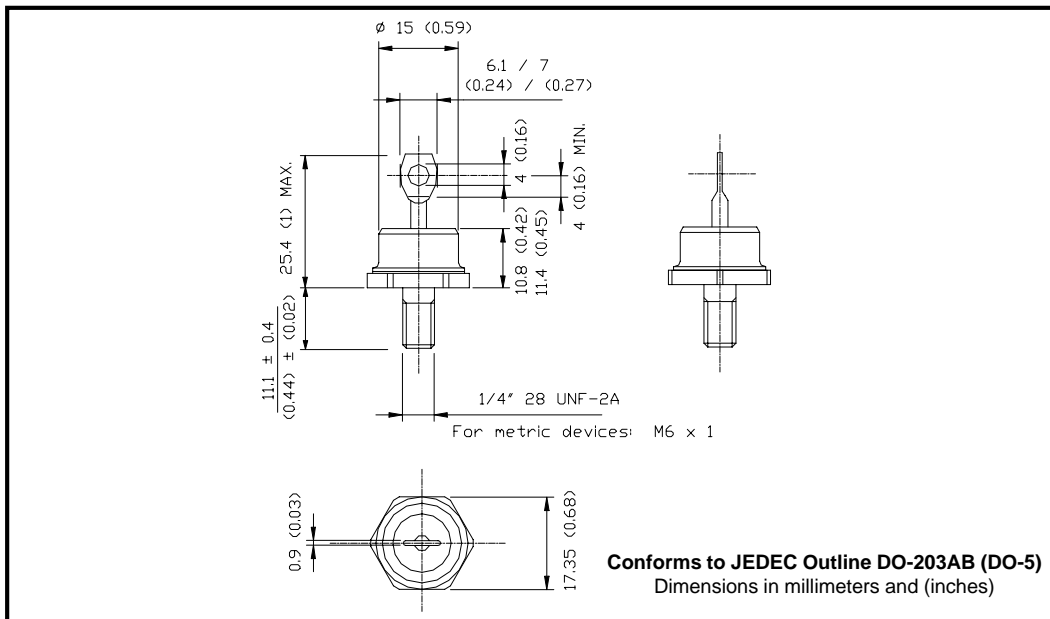

75HQ... Series

Bulletin PD-2.246 rev. C 11/02

International
IR Rectifier

Voltage Ratings

Part number	75HQ030	75HQ035	75HQ040	75HQ045
V_R Max. DC Reverse Voltage (V)	30	35	40	45
V_{RWM} Max. Working Peak Reverse Voltage (V)				

Absolute Maximum Ratings

Parameters	75HQ	Units	Conditions
$I_{F(AV)}$ Max. Average Forward Current * See Fig. 5	75	A	50% duty cycle @ $T_C = 117^\circ\text{C}$, rectangular wave form
I_{FSM} Max. Peak One Cycle Non-Repetitive Surge Current * See Fig. 7	9000	A	5 μs Sine or 3 μs Rect. pulse
	1180		10ms Sine or 6ms Rect. pulse
E_{AS} Non-Repetitive Avalanche Energy	101	mJ	$T_J = 25^\circ\text{C}$, $I_{AS} = 15$ Amps, $L = 0.9$ mH
I_{AR} Repetitive Avalanche Current	15	A	Current decaying linearly to zero in 1 μsec Frequency limited by T_J max. $V_A = 1.5 \times V_R$ typical

Electrical Specifications

Parameters	75HQ	Units	Conditions
V_{FM} Max. Forward Voltage Drop (1) * See Fig. 1	0.71	V	@ 75A
	0.88	V	@ 150A
	0.63	V	@ 75A
	0.78	V	@ 150A
I_{RM} Max. Reverse Leakage Current (1) * See Fig. 2	5	mA	$T_J = 25^\circ\text{C}$
	45	mA	$T_J = 125^\circ\text{C}$
C_T Max. Junction Capacitance	2600	pF	$V_R = 5V_{DC}$, (test signal range 100Khz to 1Mhz) 25°C
L_S Typical Series Inductance	7.5	nH	Measured from top of terminal to mounting plane
dv/dt Max. Voltage Rate of Change (Rated V_R)	10000	V/ μs	

(1) Pulse Width < 300 μs , Duty Cycle < 2%

Thermal-Mechanical Specifications

Parameters	75HQ	Units	Conditions
T_J Max. Junction Temperature Range	-65 to 175	$^\circ\text{C}$	
T_{stg} Max. Storage Temperature Range	-65 to 175	$^\circ\text{C}$	
R_{thJC} Max. Thermal Resistance Junction to Case	0.83	$^\circ\text{C}/\text{W}$	DC operation * See Fig. 4
R_{thCS} Typical Thermal Resistance, Case to Heatsink	0.25	$^\circ\text{C}/\text{W}$	Mounting surface, smooth and greased
wt Approximate Weight	15 (0.53)	g (oz.)	
T Mounting Torque	Min.	23 (20)	Non-lubricated threads
	Max.	46 (40)	
Case Style	DO-203AB (DO-5)	JEDEC	

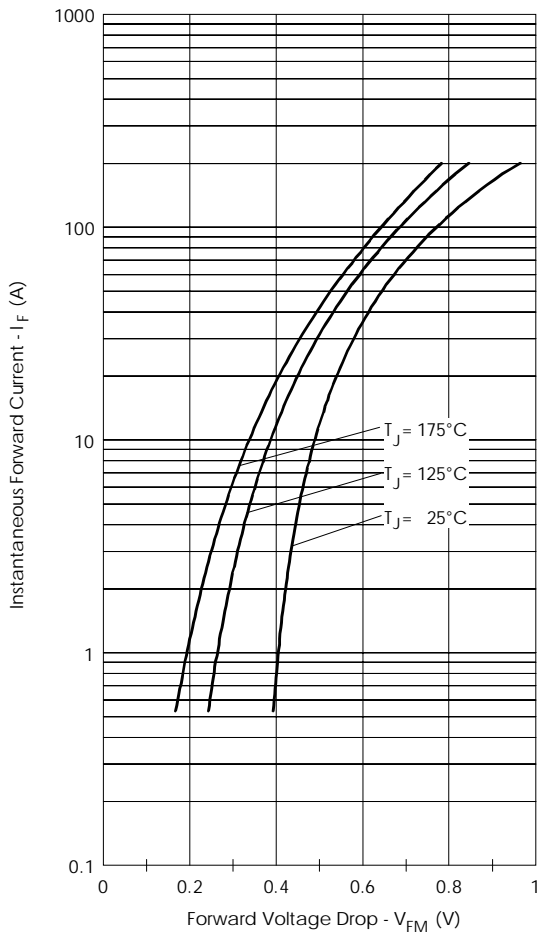

Fig. 1 - Maximum Forward Voltage Drop Characteristics

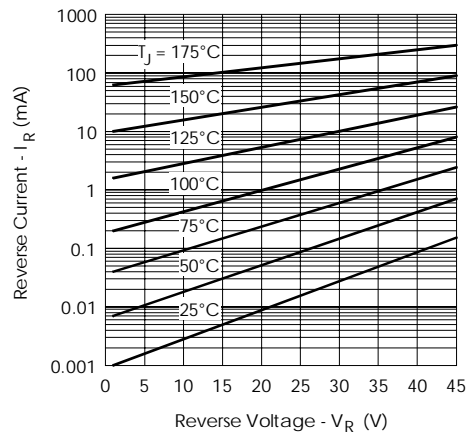

Fig. 2 - Typical Values Of Reverse Current Vs. Reverse Voltage

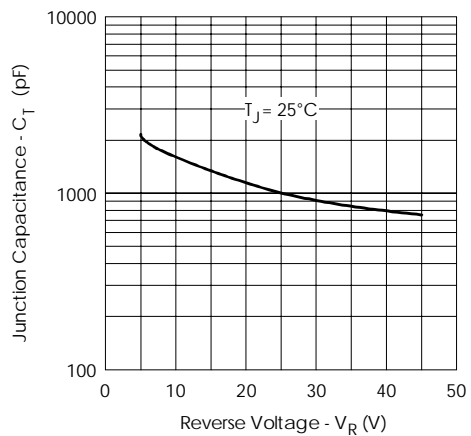

Fig. 3 - Typical Junction Capacitance Vs. Reverse Voltage

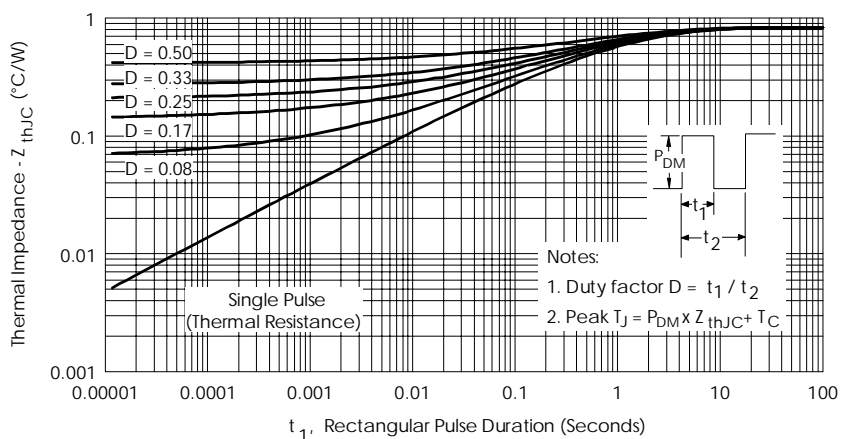

Fig. 4 - Maximum Thermal Impedance Z_{thJC} Characteristics

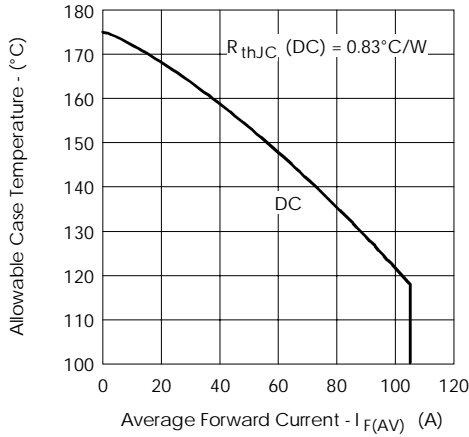

Fig. 5 - Maximum Allowable Case Temperature Vs. Average Forward Current

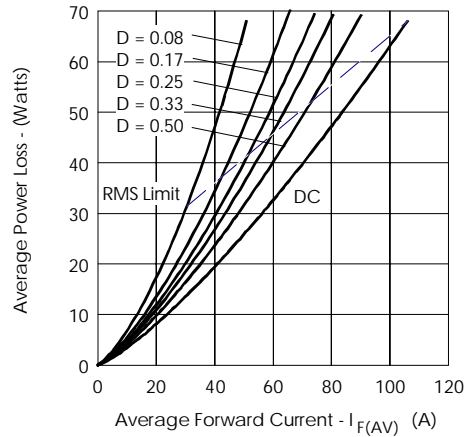

Fig. 6 - Forward Power Loss Characteristics

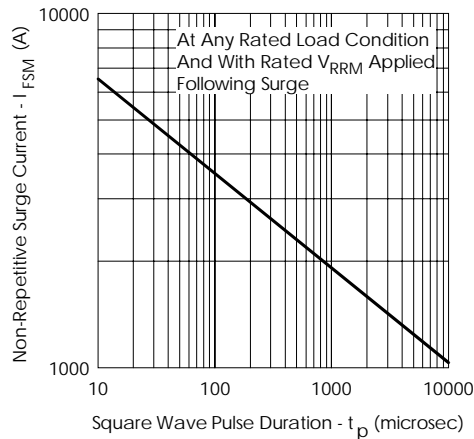

Fig. 7 - Maximum Non-Repetitive Surge Current

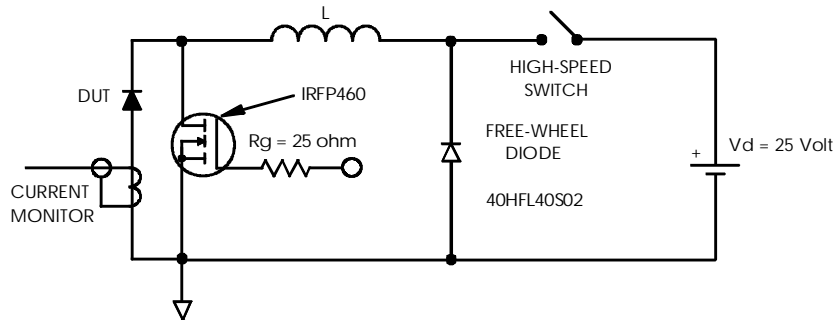

Fig. 8 - Unclamped Inductive Test Circuit

Data and specifications subject to change without notice.
This product has been designed and qualified for Industrial Level.
Qualification Standards can be found on IR's Web site.

International
IOR Rectifier

IR WORLD HEADQUARTERS: 233 Kansas St., El Segundo, California 90245, USA Tel: (310) 252-7105
TAC Fax: (310) 252-7309
Visit us at www.irf.com for sales contact information. 11/02